



**ATOMIC ENERGY CENTRAL SCHOOL No.-4, RAWATBHATA**  
**Periodic Test – II (2018-19)**  
**Subject : English**

**Class – IV**                      **Section :** \_\_\_\_\_                      **Date: 11/01/2019**  
**Name of the student :** \_\_\_\_\_                      **Roll No:** \_\_\_\_\_  
**Invigilator's sign:** \_\_\_\_\_                      **Time - 1 $\frac{1}{2}$  Hours**  
**Examiner's sign:** \_\_\_\_\_                      **MM : 40 MO : \_\_\_\_\_**

---

1. (a) Read the following passages carefully and answer the questions given below.

The blue whale is the world's biggest animal .It lives in sea water and very useful to man. In earlier days, people killed whales for their food and oil .They used whale oil for cooking and lighting. Today whale oil is used for making soaps and varnishes. But we should not kill whales because these are very few now and sometimes no whales would be left.

a) Name the world's biggest animal. (1)

---

---

b) Where does it live? (1)

---

---

c) What is the use of whale oil today? (1)

---

---

d) Put tick or cross mark.

Whales live on land \_\_\_\_\_ Whales are big animal \_\_\_\_\_ (1)

e) Arrange the words correctly. (1)

Osap \_\_\_\_\_ rwtae \_\_\_\_\_

(b) Read the following poem carefully and answer the questions given below.

### A Watering Rhyme

Early in the morning,  
Or the evening hour,  
Are the times to water  
Every kind of flower.  
Watering at noonday,  
When the sun is high,  
Doesn't help the flowers,  
Only makes them die.

Also, when you water,  
Water at the roots;  
Flowers keep their mouths where  
We should wear our boots.  
Soak the earth around them,  
Then through all the heat  
The flowers will have water  
For their thirsty 'feet'!

1. What is the best time to water the plants? (1)

---

---

2. Write the rhyming word of ; (1)

boots \_\_\_\_\_

feet \_\_\_\_\_

3. Complete the given lines. (1)

Flowers keep \_\_\_\_\_

4. Make sentence (1)

Thirsty \_\_\_\_\_

2. Look at the picture of the beach and write 5 sentences about it :- (5)

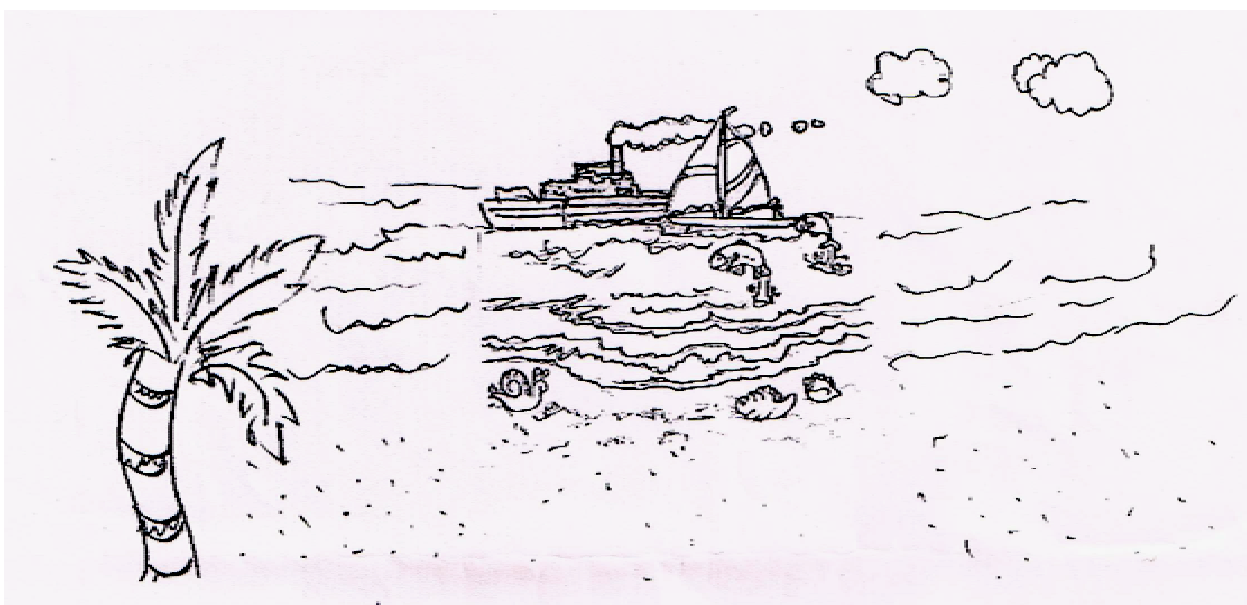

-----  
-----  
-----  
-----  
-----  
-----

3. Write five sentences on Hiawatha. (4)

-----  
-----  
-----  
-----  
-----  
-----

4. Match the words in Column 'A' with words in Column 'B' (2)

| <b>A</b> | <b>B</b>  |
|----------|-----------|
| King     | Students  |
| Teacher  | Patients  |
| Doctor   | Courtiers |
| Lawyer   | Clients   |

5. Complete the story by using an appropriate word given below (2)

**my his he your**

Mohan was a farmer. \_\_\_ wanted to sell \_\_\_\_\_ goats and sheep. So he went to the market. There \_\_\_ sold all \_\_\_ animals to a rich man and got a lot of money. When he was going back to \_\_\_ village, three thieves stopped him. "Stop! Give us all \_\_\_\_\_ money." Mohan was very clever. He said, "I'll give \_\_\_\_\_ money to the strongest of you." On hearing this, the thieves started fighting amongst themselves. Mohan slipped away quietly.

6. Answer the following questions

a) Why did the cow refused to get up? (2)

---

---

b) Who was Nokomis? (2)

---

---

c) What did Pundit claim to know? (2)

---

---

d) Who finally made the cow get up and how? (2)

---

---

7. Write true or false (2)

- a) The monkey is in the forest \_\_\_\_\_
- b) Hiawatha was a young Red Indian boy \_\_\_\_\_
- c) A baby cat is a pony \_\_\_\_\_
- d) The Scholar's mother tongue is Marathi \_\_\_\_\_

8. Fill in the blanks (4)

- a) Who is the poet of The Cruel Boy? \_\_\_\_\_  
(H.W.Longfellow, Shyamala Kumaradas)
- b) \_\_\_\_\_ language is spoken in Maharashtra. (Marathi, Hindi)
- c) The squirrel has a long \_\_\_\_\_. (tail, tale)
- d) I can \_\_\_\_\_ the bird's song.(hear, here)

9. Write the meaning of the following words: (2)

- a) Courtier \_\_\_\_\_ b) Refused \_\_\_\_\_

10. Circle the describing words. (2)

Rohit                  Clever                  Honesty                  Angry

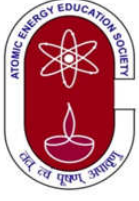

परमाणु ऊर्जा केंद्रीय विद्यालय क्र. - 4, रावतभाटा

द्वितीय सामयिक परीक्षा (2018-19)

विषय : हिन्दी

कक्षा – चौथी

अनुभाग : \_\_\_\_\_

दिनांक : 10/01/2019

विद्यार्थी का नाम : \_\_\_\_\_

अनुक्रमांक : \_\_\_\_\_

निरीक्षक के हस्ताक्षर : \_\_\_\_\_

समय : 90 मिनट

परीक्षक के हस्ताक्षर : \_\_\_\_\_

पूर्णांक : 40 प्राप्तांक : \_\_\_\_\_

प्र.1 इन शब्दों के अर्थ लिखो ।

2

खलीता - \_\_\_\_\_

पोथी - \_\_\_\_\_

हठ - \_\_\_\_\_

उत्साह - \_\_\_\_\_

प्र.2 दिए गए शब्दों के वचन बदलो ।

2

सहेली - \_\_\_\_\_

क्यारी - \_\_\_\_\_

पंक्ति - \_\_\_\_\_

समस्या - \_\_\_\_\_

प्र.3 किन्हीं दो चीजों के नाम लिखो, जिन्हें बिलोते और घोलते हैं ।

2

बिलोते हैं - \_\_\_\_\_

घोलते हैं - \_\_\_\_\_

प्र.4 इनमें कौन-कौन से ईंधन का इस्तेमाल किया जाता है ?

2

• चूल्हा - \_\_\_\_\_

• अंगीठी - \_\_\_\_\_

प्र.5 नीचे लिखे शब्दों में सही जगह पर ☺ या • का चिह्न लगाकर लिखो । 2

स्वतंत्र - ..... इतज़ार - .....  
धुआ - ..... पसद - .....

प्र.6 नीचे लिखी चीज़ों की विशेषता बताने वाले शब्द सोचकर लिखो । 2

उदा . भारी - पत्थर

..... हलवा ..... पेड़  
..... झंडा ..... नमक

प्र.7 किन्हीं चार चीज़ों के नाम लिखो, जिन्हें कुतरा जा सकता है । 2

.....  
.....

प्र.8 दिए गए शब्दों को शुद्ध करो । 2

स्वतंत्रता - ..... सत्यागृह - .....  
बिरोध - ..... अन्यय - .....

प्र.9 रई को और किस नाम से जाना जाता है ? 1

.....

प्र.10 गांधी जी के बारे में चार वाक्य लिखो । 4

.....  
.....  
.....  
.....

प्र.11 (क) कबाड़ी क्या-क्या सामान खरीदते हैं ?

2

.....  
.....

(ख) धनी बिन्नी की देखभाल कैसे करता था ?

2

.....  
.....

(ग) धनी यात्रा पर जाने के लिए उत्सुक क्यों था ?

2

.....  
.....

(घ) बच्चों ने खाने-पीने की चीज़ें छींके में क्यों रखी ?

2

.....  
.....

प्र.12 किन्हीं चार चीज़ों के नाम लिखो, जिन्हें बिखराया जा सकता है ।

2

.....  
.....

प्र.13 चूहे के अलावा कौन-कौन से जीव तुम्हारे घर में घुस जाते हैं ?

2

.....  
.....

प्र.14 'कौन' कविता के लेखक का नाम क्या है ? 2

---

---

प्र.15 कविता की पंक्तियाँ पूरी करो। 2

दोना ----- रखा रह गया

कौन उठा ले गया -----?

दो टुकड़े ----- हो गई

किसने ----- काट बहाई ?

प्र.16 गांधी जी ने अहमदाबाद के पास कौन-सा आश्रम बनाया ? 1

---

---

प्र.17 तुम अपने साथियों के साथ कौन-कौन से खेल खेलते हो ? उनके नाम लिखो । 1

---

प्र.18 धनी कहाँ जाने की ज़िद कर रहा था ? 1

---

---





**ATOMIC ENERGY CENTRAL SCHOOL No.-4, RAWATBHATA**  
**Periodic Test – II (2018-19)**

**Subject : Maths**

**Class – IV**

**Section : \_\_\_\_\_**

**Date: 09/01/2019**

**Name of the student : \_\_\_\_\_**

**Roll No: \_\_\_\_\_**

**Invigilator's sign: \_\_\_\_\_**

**Time -  $1\frac{1}{2}$  Hours**

**Examiner's sign: \_\_\_\_\_**

**MM : 40 MO : \_\_\_\_\_**

**Q.1.To draw circles on the ground Sita and Shan used nails and ropes. Sita used 1m long rope and Shan used 85 cm long rope. 2m**

- The radius of Shan's circle is \_\_\_\_\_ cm.
- Sita's circle is \_\_\_\_\_ than Shan's circle.(bigger/smaller)

**Q.2. Draw the circles of the following radius. 3m**

a. 3.5 cm

b. 2 cm.

**Q.3. Draw a design by using compass. 3m**

**Ans.**

Q.4. Draw four different ways to divide a rectangle in 4 equal parts.

2m

Ans

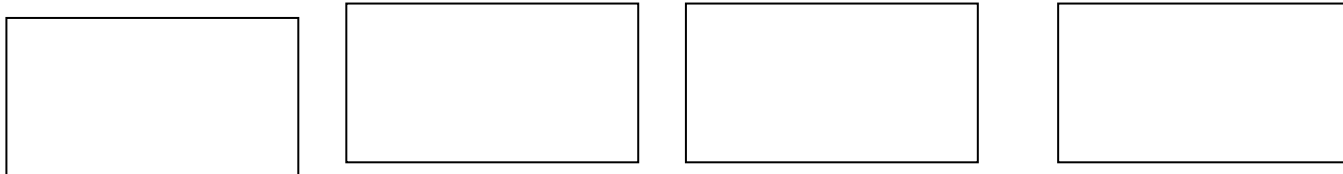

Q.5. Colour the given part of the shapes.

3m

Ans

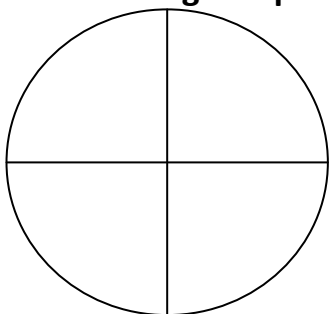

$\frac{1}{4}$

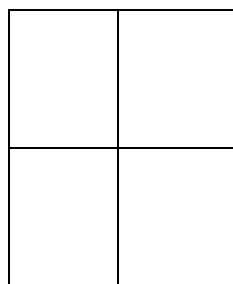

$\frac{3}{4}$

Q.6.(a) If YES becomes ZFT then what is the meaning of given secret message?

4m

HPPE OJHIU - \_\_\_\_\_

(b) If JUMP becomes 10 21 13 16 then what is the meaning of

7 15 15 4 4 1 25 - \_\_\_\_\_

Q. 7. Complete the number tower.

4m

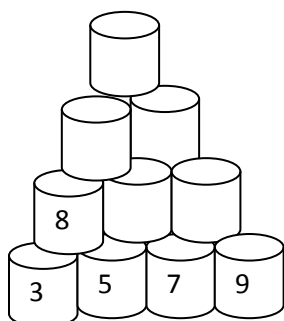
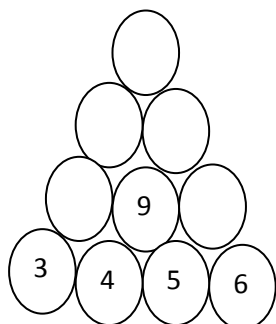

Q.8. Use numbers 1 to 9 and fill these circles and the rule is that the number on each line add up to 15 and no number should be repeated. 2m

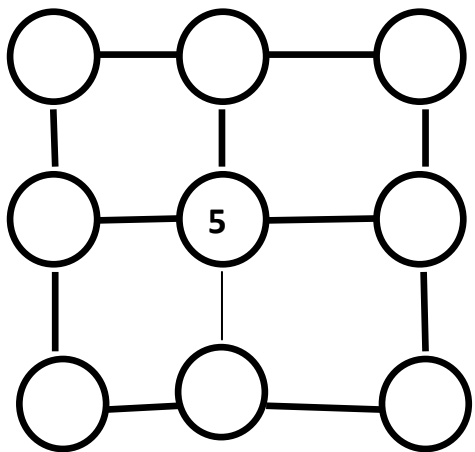

Q.9. There are 120 apples.  $\frac{1}{4}$  of them are rotten. How many apples are fresh? 2m

Ans.

Q.10. See the table and answer the given questions. 3m

| Item                 | Potato | Onion | Carrot | Pumpkin | Tomato |
|----------------------|--------|-------|--------|---------|--------|
| Price in Rs.(Per Kg) | 8      | 12    | 16     | 4       | 20     |

(i) How much does  $\frac{1}{2}$  kg tomatoes cost?

Ans.

(ii) What is the price of  $\frac{3}{4}$  kg carrots?

Ans.

(iii) What is the price of  $\frac{1}{4}$  kg onions?

Ans.

Q.11. Fill in the gaps.

5m

i)  $\frac{1}{2}$  metre = \_\_\_\_\_ cm

ii)  $\frac{3}{4}$  metre = \_\_\_\_\_ cm

iii)  $\frac{1}{4}$  metre = \_\_\_\_\_ cm

iv)  $\frac{1}{4}$  kg = \_\_\_\_\_ grams

v)  $\frac{3}{4}$  litre = \_\_\_\_\_ millilitres

vi) 4kg = \_\_\_\_\_ grams

vii) 1 kg = 350 g + \_\_\_\_\_ g + 450 g

viii) Radius is just \_\_\_\_\_ of a diameter.

ix)  $\frac{1}{4} + \frac{1}{4} + \frac{1}{4} =$  \_\_\_\_\_

x)  $\frac{1}{2} + \frac{1}{4} =$  \_\_\_\_\_

Q.12. Continue the pattern.

5m

a) 894, 794, 694, \_\_\_\_\_, \_\_\_\_\_

b) 20 Z, 18 Y, 16 X, \_\_\_\_\_, \_\_\_\_\_

c) 15, 19, 23, \_\_\_\_\_, \_\_\_\_\_

d) AB, DE, GH, \_\_\_\_\_, \_\_\_\_\_

e) 8, 18, 28, \_\_\_\_\_, \_\_\_\_\_

Q.13. Use numbers 1 to 6 to fill the boxes.

2m

Rule: Sum of each side should be 12. No number should be repeated

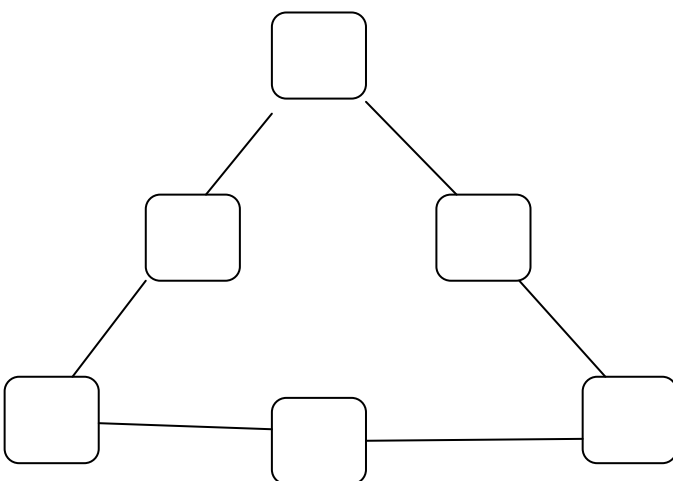



**ATOMIC ENERGY CENTRAL SCHOOL No.-4, RAWATBHATA**

**Periodic Test – II (2018-19)**

**Subject : EVS**

**Class – IV**

**Section : \_\_\_\_\_**

**Date: 08/01/2019**

**Name of the student : \_\_\_\_\_**

**Roll No: \_\_\_\_\_**

**Invigilator's sign: \_\_\_\_\_**

**Time - 1 $\frac{1}{2}$  Hours**

**Examiner's sign: \_\_\_\_\_**

**MM : 40 MO : \_\_\_\_\_**

**Q.1) Mark the following states in Map with different colours and names. 4**

1. Assam

2. Maharashtra

3. Karnataka

4. Andhra Pradesh

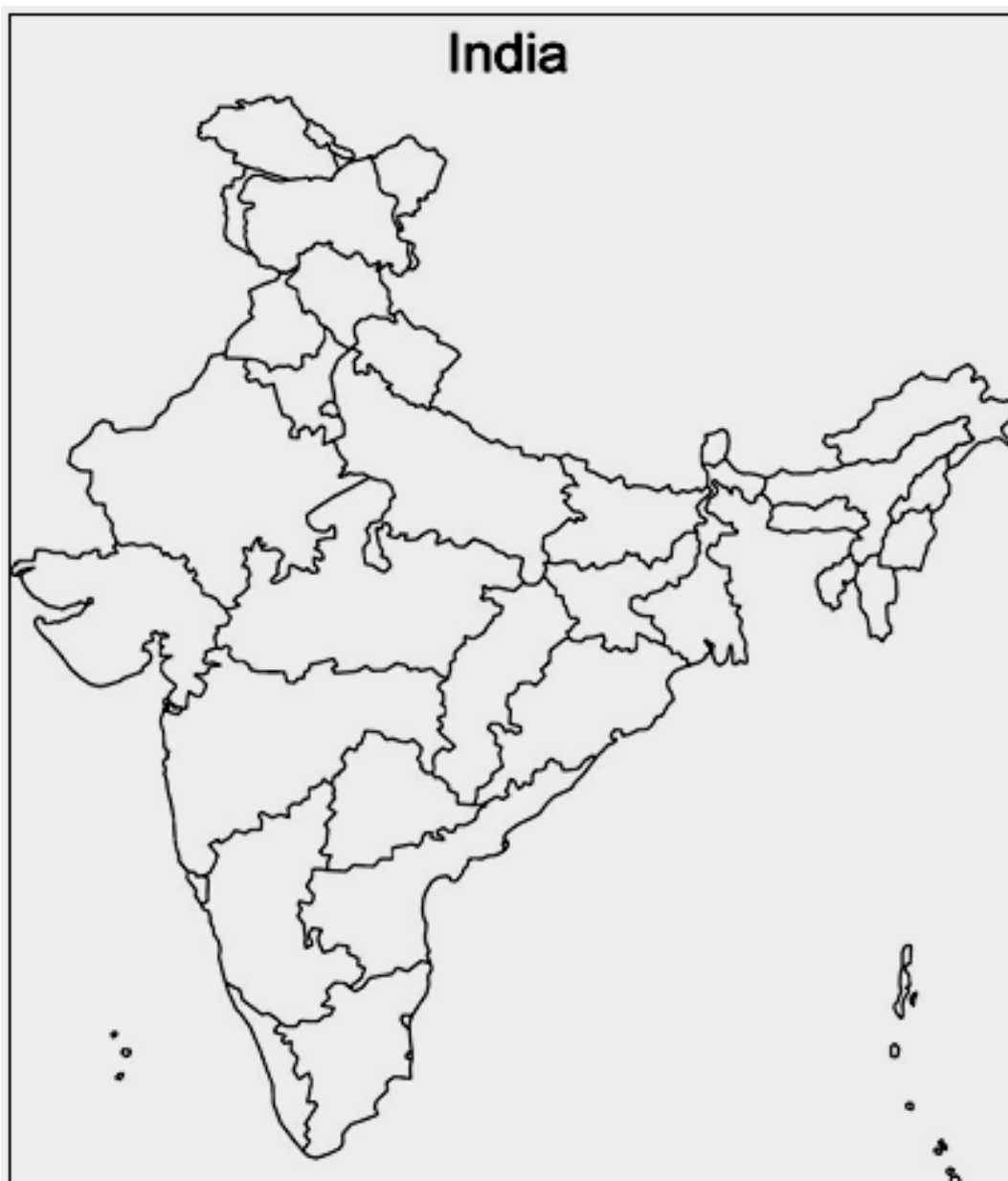

**Q.2) State whether the statements are true or false.**

**5**

- 1) Water park had no water. (            )
- 2) We need to take permission from the government to cut the tree. (            )
- 3) The Oak tree found in Australia. (            )
- 4) Lift can be seen in hut . (            )
- 5) The toilet was very neat and clean.(            )

**Q.3) Match the following**

**5**

- |                       |   |  |
|-----------------------|---|--|
| 1) Coppersmith        | : | a) twigs, dry leaves, bits of tree trunk |
| 2) Pigeon             | : | b) high upon the tree                    |
| 3) Crow               | : | c) diarrhoea and vomiting                |
| 4) Sunbird            | : | d) hole in the tree trunk                |
| 5) Dirty water causes | : | e) anywhere in the house                 |

**Q.4) Choose correct option and fill in the blanks.**

**4**

- 1) .....bird does not make its own nest. (Crow/koel)
- 2) Basva is a ..... ( farmer / driver)
- 3) House of Babloo has big .....windows. ( glass/silk)
- 4) Vaishali's whole family starts working at .....in the morning. (3AM /4 AM)

**Q.5) Give any two examples of each.**

**4**

- 1) Tools that used by farmer \_\_\_\_\_ , \_\_\_\_\_
- 2) Name of festivals \_\_\_\_\_ , \_\_\_\_\_
- 3) Birds make their nest in the house \_\_\_\_\_ , \_\_\_\_\_
- 4) Name two leafy vegetables \_\_\_\_\_ , \_\_\_\_\_

**Q.6) Answer the following questions in one or two sentences. ( any 5) 10**

1) Why does the vegetable seller sprinkle water on vegetables in summer?

---

---

---

2) Why was Raziya worried when she read the newspaper?

---

---

---

---

3) For what work the birds use their feet ?

---

---

---

4) Name any two vegetables that you can eat both raw and cooked.

---

---

---

5) Why was Nandita's Mama worried?

---

---

---

6 ) How does the water become dirty ?

---

---

---

**Q.7) Draw the following pictures neatly.**

**4**

1) Khunti

2) Illige

**Q. 8) Write what happen-**

**2**

i) If we are late to take out the onion crops then

---

---

---

ii) If we do not remove the weeds from onions field then

---

---

**Q.9) What are the different materials do, birds use when they build their nests ?**

**1**

---

---

**Q.10) What do you mean by Bheema Sangh ?**

---

---

-----\*\*\*\*\*-----